



SilencerCo Specwar

Field Manual

Thank you for choosing to add a SilencerCo suppressor to your collection. We love what we do and take great pride in the products we produce, and hope you will enjoy using this product as much as we enjoyed making it.

Each SilencerCo product carries our Lifetime Warranty. Should you have any questions after reading this manual, our best-in-class customer service team will be glad to assist you.

Again, thank you for joining SilencerCo as we work to **#FightTheNoise**.

Sincerely and Silently,



Joshua Waldron
SilencerCo Co-Founder & CEO

SPECWAR





We at SilencerCo® hope that you enjoy the technological advancements offered by the Specwar™ sound suppressor. To provide for your safety and the effective use of this suppressor, it is critical that the owner and any user of the suppressor read this entire manual and follow strictly the warnings and instructions within. This suppressor is intended to be used only by those who are well-versed in the safe operation of firearms.

DISCLAIMER

The manufacturer is not responsible for improper usage of this product. This product is potentially dangerous, and, as such, it is the user's responsibility to understand and implement its proper use. If you do not understand the instructions in this manual, please contact the manufacturer for further clarification at 801.417.5384

SONIC CRACK

The Specwar is designed to suppress the initial muzzle blast and subsequent projectile de-corking pressure. The Specwar does not contact or otherwise interact with the projectile, allowing the projectile to travel at its default speed. Because of this, a sonic crack is produced by the projectile as it breaks the sound barrier. Depending on the geography of the area, the sonic crack may vary in volume. This is solely a function of the projectile breaking the sound barrier and is not related to suppressor performance.

WARNING

Failure to follow installation and maintenance instructions detailed in this manual may result in serious personal injury and damage to the weapon. Firearm sound suppressors are user-attached firearm muzzle devices, and as such are subject to improper attachment issues unless the procedures outlined in this manual are followed precisely. Do not attempt to use this product unless you have specific training and experience in the use of firearms.

Before installing or removing the Specwar sound suppressor from the host weapon, be sure that the weapon is unloaded and the action is opened so that it is visibly clear of any ammunition. If you are at all unsure as to the proper procedures to ensure that your firearm is unloaded, please consult your firearm user's manual/instructions and/or contact a properly licensed dealer or the manufacturer of your weapon.

Because suppressed firearms make less noise than unsuppressed firearms, it is easy to forget that they are still firearms and capable of causing bodily injury

and property damage. It is of vital importance to remember that a suppressed firearm is just as dangerous as an unsuppressed firearm, and that the same safe handling requirements still apply.

When removing the Specwar, use extreme caution as it may be hot to the touch after firing. Use gloves to avoid burns or other injuries.

Check the fit between barrel and suppressor before firing! The thread mount must be fully shouldered on the barrel. There should be no visible gap between the barrel shoulder and the face of the suppressor thread mount. If there is any gap DO NOT fire the host with the suppressor attached. Poor accuracy and product damage may result if the suppressor is not fully shouldered.

Assembly and disassembly should never be performed while the suppressor is affixed in any manner to a host firearm. Always completely remove the Specwar from the host firearm before assembly and/or disassembly is attempted.

MADE IN THE USA

The Specwar mounts to a proprietary flash hider or muzzle brake and features the patent-pending Active Spring Retention (ASR)[™] mounting system for solid, trouble-free lockup. Installation and removal of the suppressor takes mere seconds, and can be completed single-handedly. Ease of installation and an uncompromising dedication to durability make the Specwar a top choice for both 5.56 and 7.62 host firearms.

The Specwar was designed for precision bolt action, semi-auto, and intermittent full-auto firearms.

Note: Suppressors must be free of obstructions such as mud, dirt, etc. Do NOT attempt to shoot through an obstructed suppressor.

The Specwar was designed to be used “dry” and free of any abrasive media, such as grease and water. Water-borne operators must allow a minimum 6 second drain time after exiting the water.

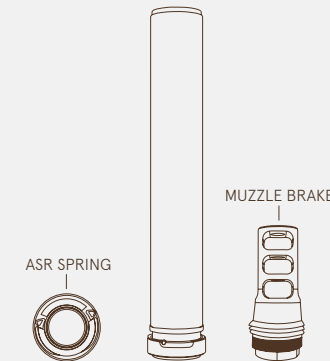

SPECWAR 762

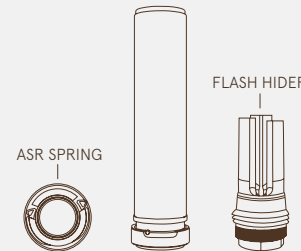

SPECWAR 556

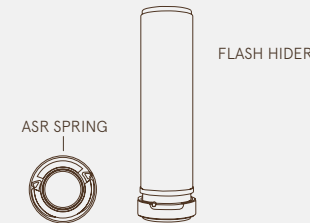

SPECWAR K 556

PRODUCT SPECS

INCLUDED

The Specwar 762 ships with a shim kit to be used with the included muzzle brake.

MOUNTING

The Specwar attaches to the host firearm via a proprietary mounting system.

Note: Crush washers are NOT recommended as they do not crush uniformly and WILL cause improper mounting and baffle strikes. SilencerCo recommends a shim if any clocking of the mount is required.

For proper alignment, it is essential that the flash hider/muzzle brake seats against a 90° barrel shoulder. The flash hider/muzzle brake should be torqued to a value of 20-30 ft-lbs. Use of Rocksett or RED Loctite is recommended.

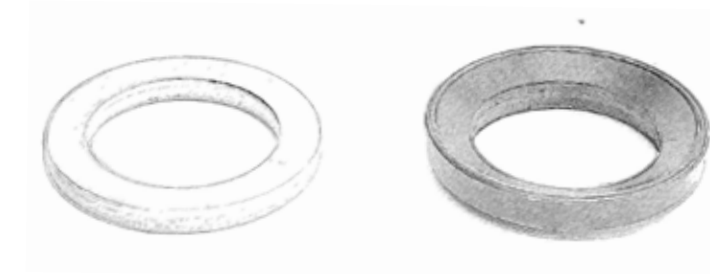

PEEL WASHER

CRUSH WASHER
(DO NOT USE)

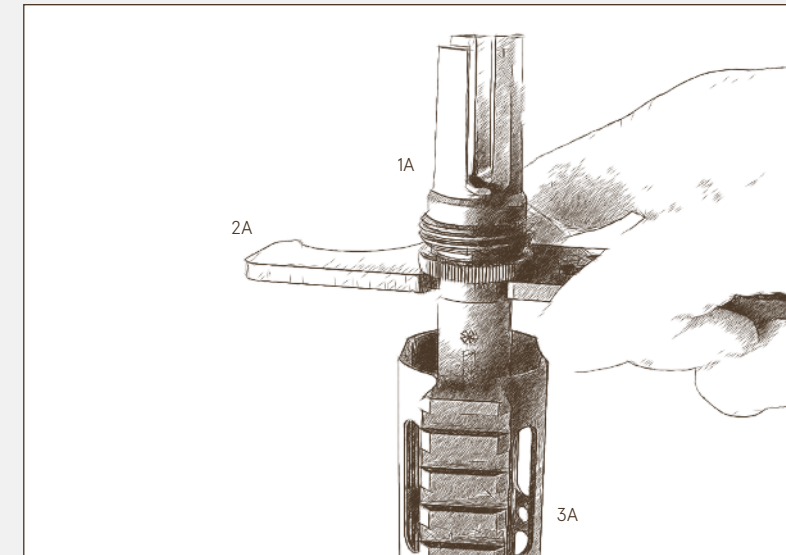

INSTALLATION

Step 1: Remove your existing flash hider (1A) or muzzle brake using a 3/4" open end wrench (2A). Remove the crush washer from barrel threads.

Step 2: Install one of the Specwar mounts by threading it onto the barrel (3A). Utilize provided shim kit for muzzle brake timing on the Specwar 762. Tighten onto barrel using a 3/4" open end wrench (2A).

MOUNTING

Step 3: Install the Specwar by sliding the back end (1B) over of the barrel mount (2B) until it stops, then turn clockwise to hand tighten.

Note: Verify the ASR collar (3B) is in the unlocked position before installing.

Step 4: Rotate the ASR collar (3B) clockwise to the locked position.

To remove, perform steps three and four in reverse order.

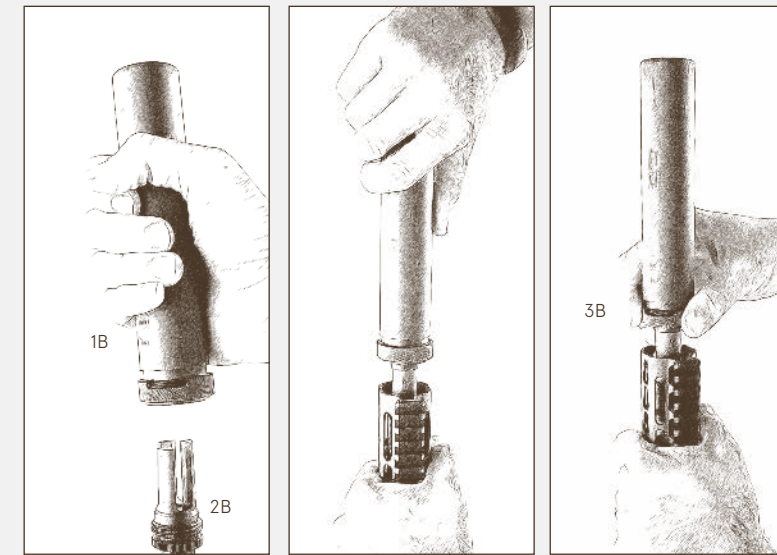

MAINTENANCE

The Specwar series of suppressors typically requires limited maintenance.

Mounts should periodically be cleaned with any standard gun cleaning solvent and a brush to remove any carbon or fouling. If the finish becomes discolored, wipe the suppressor with any high quality gun oil. This should restore the finish to the factory condition.

While not required, the end user may submerge the Specwar in solvent, oil, gun cleaner, etc. to remove fouling. Allow the suppressor to drain fully and blow out with compressed air until dry. If necessary, run a cleaning brush through the bore to remove any light fouling of the suppressor.

Note: Do not run cleaning patches through the bore as the patches might become lodged in the suppressor and cause damage upon firing.

Caution: Always read the warning label on any cleaner or solvent, and remember that virtually all solvents are inherently dangerous and potentially toxic. Always use adequate ventilation and both skin and eye protection when using solvents.

LIMITED LIFETIME WARRANTY

LIMITATIONS TO WARRANTY: THIS WARRANTY DOES NOT COVER DAMAGE TO THE SUPPRESSOR OR THE HOST FIREARM RESULTING FROM CARELESS OR IRRESPONSIBLE HANDLING, ADJUSTMENTS OR MODIFICATIONS TO ITS DESIGN, NEGLIGENCE, OR OTHER ABUSE. SILENCERCO ASSUMES NO LIABILITY WHATSOEVER FOR UNSAFE USE OF THE SUPPRESSOR OR ILLEGAL USE BY ITS PURCHASER OR ANY OTHER PERSON THAT COMES IN CONTACT WITH THE PRODUCT AFTER PURCHASED. SILENCERCO ASSUMES NO RESPONSIBILITY FOR PHYSICAL INJURY OR PROPERTY DAMAGE RESULTING FROM CARELESS OR IRRESPONSIBLE HANDLING AND/OR USE, OR BY ANY USE CONTRARY TO THE RECOMMENDATIONS, WARNINGS, AND CAUTIONS GENERALLY LISTED IN THIS MANUAL. SILENCERCO DOES NOT COVER DAMAGE TO THE SUPPRESSOR OR THE HOST FIREARM RESULTING FROM IMPROPER HAND-LOADED OR RELOADED AMMUNITION OR DEFECTIVE AMMUNITION.

REPAIR POLICY 01

Should the silencer require repair or modification, the owner should contact SilencerCo either in writing or by telephone. Many problems can be handled without having to return the product. If it is determined that the product needs to be returned for repair or modification Contact SilencerCo customer service 801.417.5384 where an RMA number will be provided. Do not return the suppressor to SilencerCo until you have contacted customer service as an RMA code must be provided.

If repairs are required due to a defect in manufacturing or materials, there will be no charge for repairs.

Subject to any restrictions set forth herein, SilencerCo agrees to replace and/or repair the Specwar for an unlimited amount of time. This warranty covers repair, service, and replacement of damaged product caused by normal use, free of charge, only if performed at a SilencerCo facility.

REPAIR POLICY 02

Should a silencer require repair, the owner must contact SilencerCo and make arrangements to return the product. Customer must return damaged product with a legible copy of the approved ATF form and a legible written description of the problem, defect, and/or malfunction. Please include in written description the serial number of the product and the events leading up to the issue, including what ammunition has been used and any host weapons that have been used.

If SilencerCo determines, at its sole and absolute discretion, that a returned suppressor is not covered under this warranty, for any reason, you may purchase a replacement product at 75% off the suggested retail price.

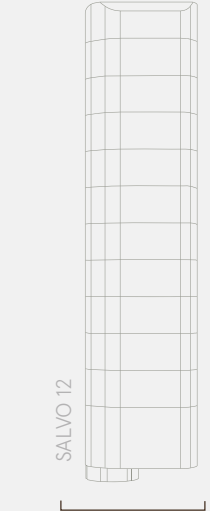

SHOTGUN SUPPRESSOR

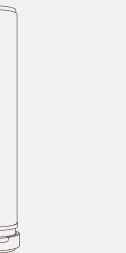
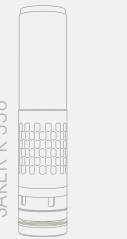
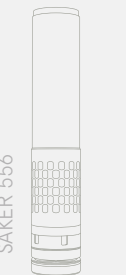
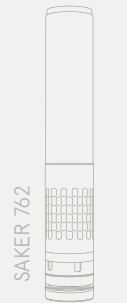
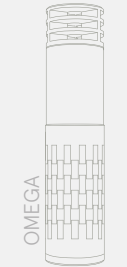
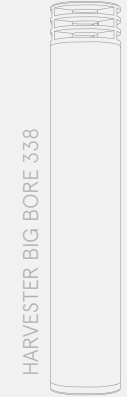

CENTERFIRE RIFLE SUPPRESSORS

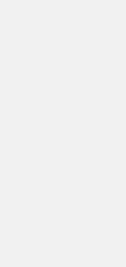
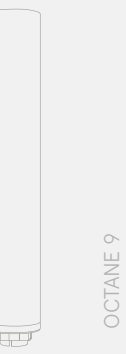
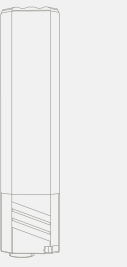
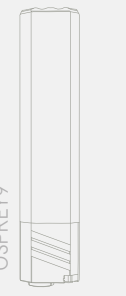

PISTOL SUPPRESSORS

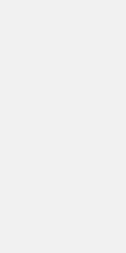
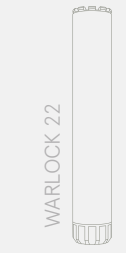
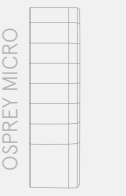

RIMFIRE SUPPRESSORS



Register your SilencerCo Product Online To Activate Your Lifetime Warranty

WWW.SILENCERCO.COM/PRODUCT-REGISTRATION



 **Follow Us**

Join ASA Today

PROTECT YOUR RIGHTS | PROTECT YOUR HEARING





The American Suppressor Association
is fighting to protect and expand your
suppressor rights. Join the fight today!

Become a member at
WWW.ASAMEMBER.COM

Contact us at:
INFO@AMERICANSUPPRESSORASSOCIATION.COM

Follow Us



/SILENCERCO



/SILENCERCO



@SILENCERCO



@SILENCERCO



Note: If you have any questions whatsoever about whether you are performing the assembly, disassembly, or cleaning of the suppressor properly and in accordance with these instructions, you may contact SilencerCo customer service by phone at 801.417.5384 or via email at info@silencerco.com

For a list of available mounts and suppressors visit SILENCERCO.COM/PRODUCTS/SPECWAR

© 2015 SilencerCo, LLC. All rights reserved. The contents of this publication may not be reproduced in any form or by any means in whole or in part without the prior written permission of the copyright owner.

